



Hospitality

Security and Access Solutions

ASSA ABLOY
Global Solutions

Experience a safer
and more open world

1. The Company 3

- : ASSA ABLOY Global Solutions
- : Why ASSA ABLOY Global Solutions?
- : Your Total Solution Provider

2. Mobile Access 8

- : Three Different Solutions
- : Benefits
- : How it Works

3. VingCard Locks 14

- : VingCard Allure
- : VingCard Essence
- : VingCard E100 and C100
- : VingCard Signature
- : VingCard Classic
- : VingCard Flex
- : Options, Finishes and Handles
- : Optional Designers' Collection
- : VingCard Locks Comparison Table

4. Elsafe Safes 30

- : Elsafe Infinity II
- : Elsafe Sentinel II
- : Elsafe Zenith
- : Comparison Table
- : Additional Features

5. System & Software 39

- : Visionline
- : Visionline Software Packages
- : Visionline Features and Benefits
- : Vostio Access Management
- : Vostio Benefits
- : IoT Location Solutions
- : Staff Safety

6. Accessories 49

7. Worldwide Service 55



The Company

ASSA ABLOY Global Solutions

Our story began in 1974, when lock maker Tor Sørnes heard that an intruder had attacked his favorite singer in her hotel room.

Inspired to help, he resolved to invent a security system that would provide a unique key for every guest. His invention changed the whole lock industry.

As industry pioneers we've always led the way – employing innovative technology to make people feel safe and secure wherever they want to go.

ASSA ABLOY Global Solutions has products installed in more than 42,000 properties worldwide, securing in excess of 7 million hotel rooms. We continue to use advanced technology to offer security and peace of mind to both hospitality providers and their guests. ASSA ABLOY Global Solutions's extensive international network covers more than 166 countries.

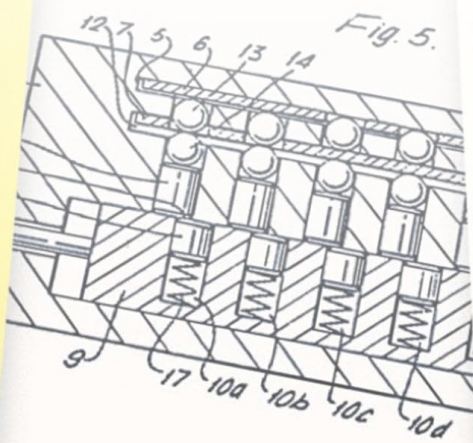
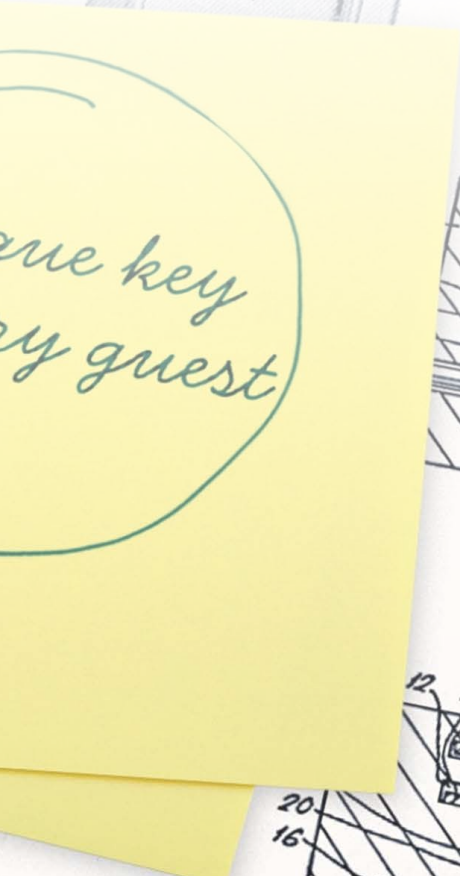

Den første prototypen på VingCard låsen.

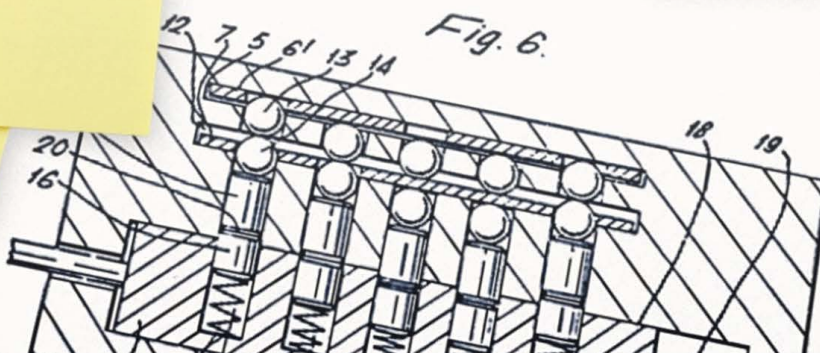

The Company

Why ASSA ABLOY Global Solutions?

Our purpose is not simply to lock and unlock more doors—it is to unlock the feeling of safety, security and belonging for more people, wherever they want to go.

We know what it takes to unlock a feeling of security, for hotels and their guests. Our Scandinavian design is well-known throughout the world for the quality, functionality and durability it represents. Since we invented the first card lock system in 1979, we have continued to innovate and deliver high quality electronic locks and safes to the hospitality industry.

We bring experience, knowledge, modern technology and the finest materials to the task. By focusing on industry trends, modern manufacturing facilities, internal resources and a close dialogue with our customers, ASSA ABLOY Global Solutions has been able to continuously develop solutions to match customer needs. Our vast array of solutions and services are created with full compatibility in mind in order to meet the unique demands of any property or resort.

Designed according to the most demanding standards, VingCard's electronic locks are tested to more than 1 million openings. Based on a heavy duty mortise lockcase and a solid escutcheon, the lock is as solid as it is secure. Solid brass handles fastened on the inside of the escutcheon with self-lubricating long-life bearings ensure maximum security and a true quality touch and feel.

In setting a new standard in electronic safe security design, ASSA ABLOY Global Solutions currently produces the industry's only UL-1037 certified safe, providing guests and their valuables with the highest level in hotel security.

We are dedicated to offering advanced security solutions and peace of mind for both hospitality providers and their guests.

“We are working every day to
reimagine how people move
through the world of hospitality.”

Markus Boberg
Global President, Hospitality
ASSA ABLOY Global Solutions



ASSA ABLOY Global Solutions
Your Total Solution Provider



RFID Elevator Controller



Bathroom Lock



Essence Electronic Lock



Mobile Access Solution



Polarbar Minibar



Signature Electronic Lock



Locker Lock



Sentinel II Electronic Safe



Allure Electronic Lock



Visionline System



RFID Remote Controller

Welcome back!
You are ready to
start check in



RESERVATION
Augusto Hotel Villa
25-28 May

START CHECK IN



2. Mobile Access

Always setting the pace in hospitality innovation, ASSA ABLOY Global Solutions has played an integral part in developing and implementing mobile access technology throughout hospitality markets around the globe. A highly advanced mobile phone-based keyless entry solution, Mobile Access has already been installed in tens of thousands of guestrooms worldwide.

Powered by Seos®, the first ever multi-platform ecosystem for issuing, delivering or revoking digital keys, properties equipped with Mobile Access can provide guests with the ultimate check-in convenience by allowing them to use personal devices as a room key and bypass the front desk entirely.

As a result, this proven technology solution can provide the added benefits of more streamlined front desk operations and reduced costs to the hotelier.

Mobile Access

Three Different Solutions

You can choose between three variations of the solution depending upon your needs.

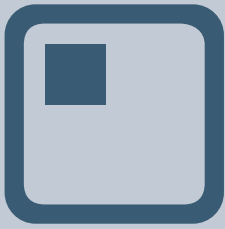

Customer Integration

This solution is created for hotels with their own app initiatives that want to integrate mobile access into their own apps and back end systems. ASSA ABLOY Global Solutions provides a Mobile Access Software Development kit (SDK) together with dedicated onboarding services to facilitate seamless integration.

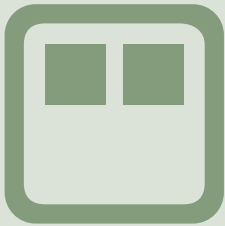

Third-Party (Certified Partners)

This solution suits hotels that want mobile app functionality beyond access control alone, but don't yet have their own in-house app initiatives. They can choose a solution from one of our selected app specialist partners, who through our Certified Partner Program have already integrated our mobile access functionality into their products.



ASSA ABLOY Global Solutions Mobile Access App

This is our own ready-to-use, off-the-shelf solution. The app suits hotels that want to provide basic mobile access solutions to their guests in a simple to use format. There are no integrations or third-party dependencies required.

We publish a general app that is available in the App Store and on Google Play. Through an administration portal, hotels can customize their digital key graphics to reflect company branding or design. This will then show in a "Passbook" inspired style for the hotel to use.



Mobile Access Benefits



Unique user experience

Mobile Access offers guests a whole new hotel experience. Depending on the solution deployed they can reserve and book their room using their mobile phone or device. They can then use the phone to check in and check out.

Skip front desk - No queues

When guests arrive, guests can go straight to their room using their own smartphone to open the door. No need for keys or keycards. There is no need to wait in a queue at the front desk after a long journey. This seamless experience is secure, convenient and saves everyone time.

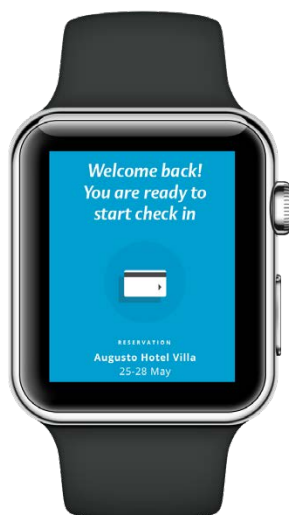

Better guest experience

By improving service levels and the guest experience, Mobile Access builds customer loyalty as well as the hotel's image and brand. Such a central feature adds value to hotel's mobile strategies, making them more relevant to a hotel's customers.

Operational efficiencies and guest service

On the operational side, Mobile Access streamlines front desk operations, reduces cost and frees up the front desk team to focus on other important aspects of guest service.

Increased loyalty and profitability

Mobile Access technology facilitates one-to-one communication with the hotel guests, ultimately driving customer loyalty and revenue. Together all the benefits of Mobile Access lead to enhanced hotel image and guest loyalty. This, creates more efficient operations that reduces cost driving revenue, improved profitability and increased competitiveness.

Mobile Access

How it Works

Regardless of the solution deployed, the same core Mobile Access will give guests an experience that is convenient, secure and timesaving.



1

An icon showing a man and a woman standing next to a smartphone. The man is on the left, wearing a suit, and the woman is on the right, wearing a dress. The smartphone is positioned in front of them.

The hotel guest downloads the app, registers his/her smartphone through the app and allows push notifications.

2

An icon showing a smartphone on the left and a calendar on the right. A curved arrow points from the calendar to the smartphone.

The guest makes a reservation and approximately 24 hrs. before arrival, he/she is invited through a push notification to use Mobile Access and start the check-in process.

3

An icon showing a hand holding a smartphone. The hand is on the left, and the smartphone is on the right.

The guest receives a push notification noting that he/she is checked in and the app will update with the room number and the digital key when the room is ready.

4

An icon showing a hotel building with a palm tree in front of it. The building is on the right, and the palm tree is on the left.

Upon arrival the guest can bypass the front desk and go directly to his/her room.

5

An icon showing a smartphone on the left and a door lock on the right. A curved arrow points from the smartphone to the door lock, and there are three curved lines representing a signal between them.

After ensuring that the Bluetooth is enabled, the guest simply holds the smartphone to the door lock, waits for the solid green light and enters the room.



“Imagine the convenience of being able to open doors through a digital key stored on your smartphone... Now you can.”





3. VingCard Electronic Locks

Designed according to the most demanding ANSI grade 1 standards, VingCard's electronic locks are tested to more than 1 million openings. Based on a heavy-duty mortise lockcase and a solid escutcheon, the lock is as solid as it is secure. Stainless steel handles fastened on the inside of the escutcheon with self-lubricating long life bearings ensure maximum security and a true quality touch and feel.

Since 1979, research and development has been a key element for us in finding new solutions for the future. By working together as a team, using our learning experience from the market and combining it with our know-how, we are able to develop tomorrow's solutions.

The modular construction makes it easy to change and service parts without changing the complete lockset. Due to our future-proof philosophy the lock software can be upgraded in the field at any time when needs change without changing or removing any hardware.

Electronic Locks

VingCard Allure

VingCard Allure is a designers' dream. Unique design and exceptional features make Allure more than imagined. Its appearance is not like traditional locks and it is more flexible than ever before. Appearance and functionality can now be chosen based on specific needs and desires for the property. Both Allure Grand and Solo support Mobile Access and can be ready to use simply by adding our BLE module.

Features:

- The industry's most advanced and secure RFID technology
- Wall-mounted panel with LED light information indicators
- Wall reader with customizable intelligence and functionality
- Stylish panels with flexible design options
- Illuminated room number option with 16 selectable LED light color themes
- Inside panel for setting "Do Not Disturb" (DND) and "Make Up Room" (MUR) status
- Standalone solution for DND/MUR setting and status display
- Wireless communication between wall and door unit
- Online connectivity with Visionline Wireless (ZigBee) or Visionline Wired (PoE)
- Integration with GRMS

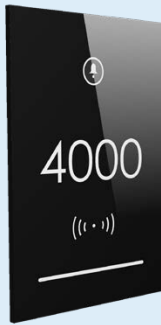

ACCESS PANEL

The most advanced VingCard Allure panel has all available functions included.

You get an RFID lock, based on VingCard's well-known RFID locking solution and quality, "Make Up Room" (MUR) and "Do Not Disturb" (DND) status indicators, a doorbell button and room number display.



ROOM STATUS PANELS

When a lock is not required, Allure can also be supplied as a room status panel with MUR and DND indicators, in addition to a doorbell button.

This panel is suitable if you already have an electronic locking solution or for rooms where a lock is not required, such as a conference room.



IN-ROOM PANELS

To activate the MUR and/or DND room status, it is necessary to have an in-room switch panel. This panel can be installed wherever it is suitable or convenient.

VingCard's room bus system also allows multiple panels within one room or suite.

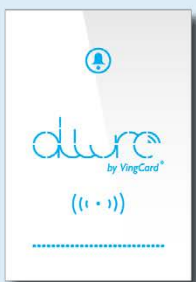
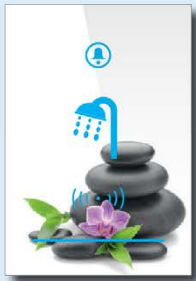
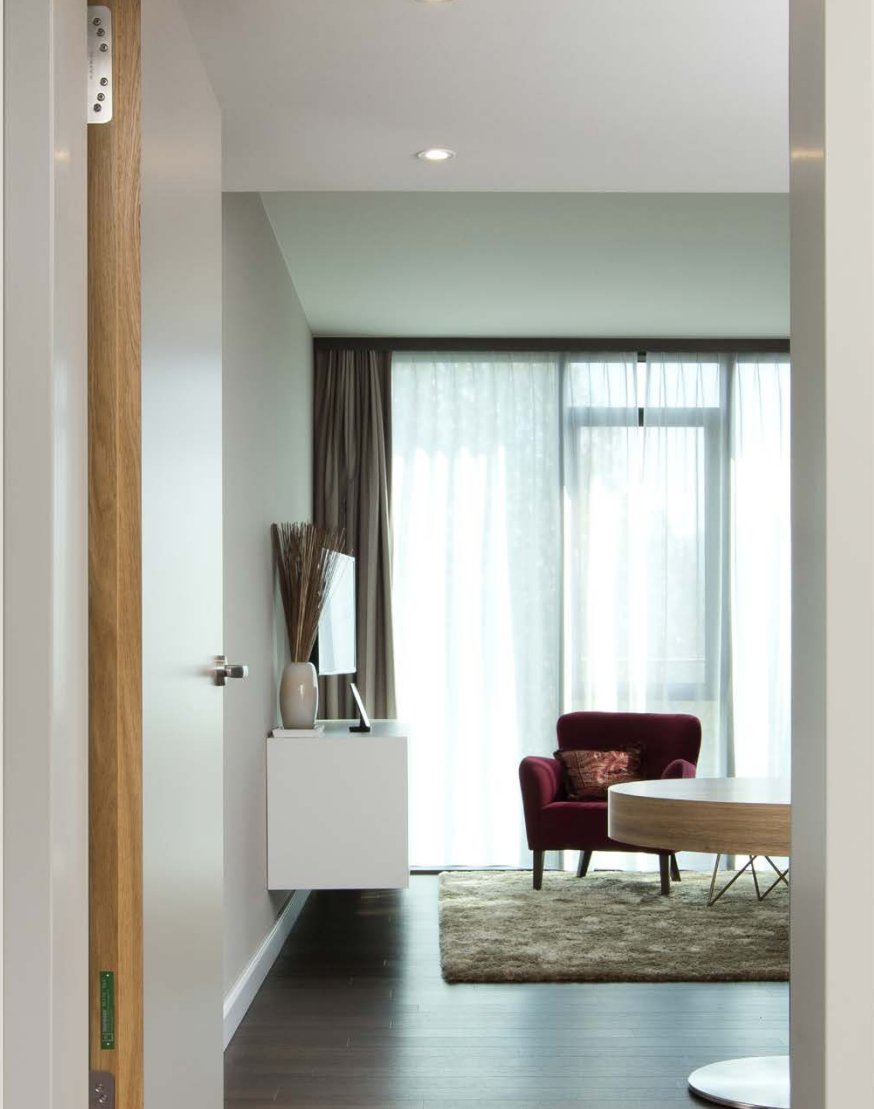

Electronic Locks

VingCard Essence

VingCard Essence revolutionizes the electronic lock industry by housing all lock components, including the reader and mobile access board, inside the door. Reaching the maximum minimalistic expression, it is the true essence of an electronic lock.

VingCard Essence is always delivered as Mobile Access ready. With the Mobile Access board included inside the reader, your property is ready for using mobile phones as guestroom keys whenever needed.

Features of VingCard Essence

- Minimalistic design with electronics inside the door
- Provides a wide range of design options for handles
- RF Online capability (wireless)
- New stylish reader design
- RFID reader with improved reading distance

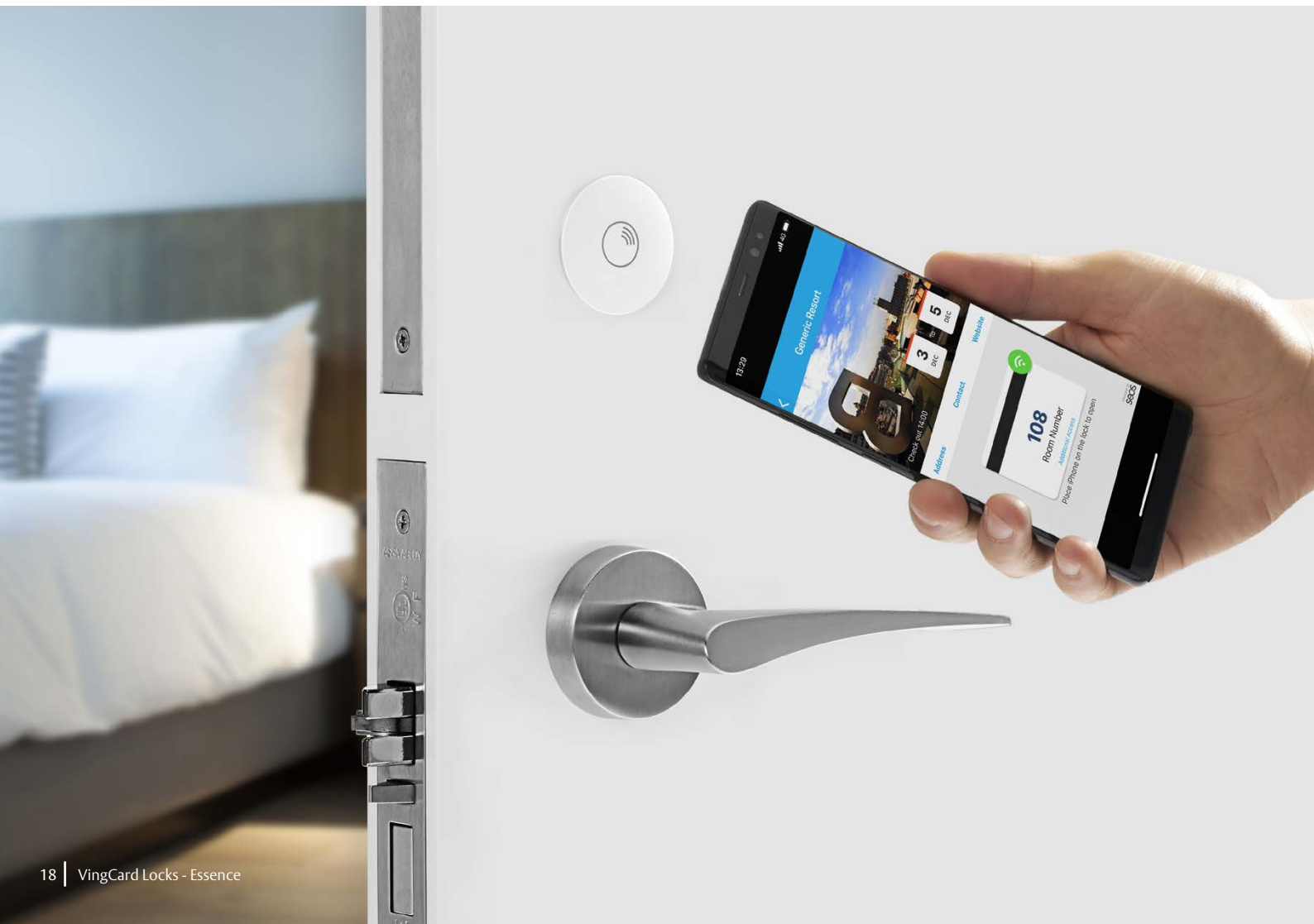

Electronic Locks

VingCard E100 and C100

The VingCard E100 and C100 is supported by the Visionline system and software. With a wide range of products for different regions and cylinder profiles, the E100 and C100 can be used with a variety of door types such as sliding doors, glass doors and aluminium profile doors. The range is suitable for both guest room doors and back of house applications where the door types may vary.

Currently not available in US & Canada. Available where German DIN and Scandinavian Industry Standards (SIS) applies.



E100



C100



Electronic Locks

VingCard Signature

With Signature RFID you are provided with a stylish and modern lock that appeals to the modern hotel environment. Signature RFID is less on the door and more for you and your guests in terms of functionality and user friendliness.

Upgrade to RFID Technology

- 3-5 minute operation.
- No need to replace the lockcase or handles.
- No drilling required.
- No downtime in room availability.
- No disturbance for your guests.



Electronic Locks

VingCard Classic

Classic RFID derives from the standard Classic lock and allows you to go contactless in a few short steps if you already have standard Classic installed. With its sleek and elegant design, available in all VingCard lock finishes, you now have a second method of upgrading to RFID functionality depending on your choice of style.

Upgrade to RFID Technology

- 3-5 minute operation.
- No need to replace the lockcase or handles.
- No drilling required.
- No downtime in room availability.
- No disturbance for your guests.



Electronic Locks

VingCard Flex

With VingCard Flex you are provided with a robust RFID lock that is specially developed for upgrading properties from Timelox S-series installations to the newest RFID lock hardware platform without drilling the door. VingCard Flex is fully compatible with the latest solutions for Mobile Access and RF online communication.

- 3-5 minute installation time
- No need to drill holes or use mortise tools
- Keep old Timelox lock cases for even greater upgrade savings
- Tubular latching compatible
- Update to RFID and Mobile Access quickly and affordably
- Less maintenance compared to magstripe
- Supports Zigbee online functionality



Electronic Locks

Options, Finishes and Handles

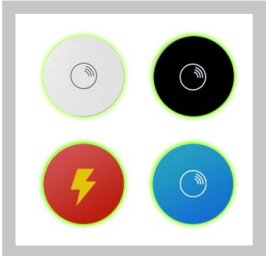

Custom reader design

ASSA ABLOY Global Solutions offers a range of lock reader covers with customized colors and logo designs. Black and white are the standard colors, however a more unique design can be ordered upon request. Contact your local sales representative to learn more about your reader design options.

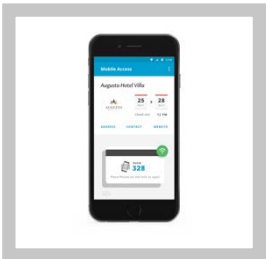

Mobile Access

The latest generation of all VingCard RFID locks (Allure, Essence, Signature, Classic and Flex) are compatible with Mobile Access. The only thing needed is to add a small Bluetooth Low Energy (BLE) board to the lock.



Cylinder options

VingCard locks may also be supplied with an optional mechanical key override cylinder.

- Use of mechanical key override is registered in the lock memory for audit trail.
- Mechanical cylinder can be either visible or not visible with a cylinder concealer (Signature only, finish may vary from lock finish).
- Superior pick resistance through its 7 pin high security profiles and narrow channel paracentric keyway and anti-pick drivers.
- Unique cylinder fixing for added security.
- 5 times recodable cylinder.
- Cylinder is available in all lock finishes.

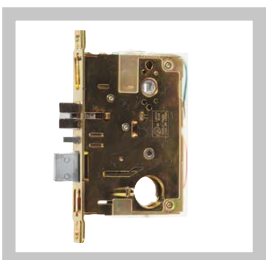

Automatic deadbolt option

The automatic deadbolt lockcase has been produced to provide our customers and their guests with an added measure of security. Automatically extending the deadbolt upon door closure ensures that the security of the deadbolt is present without the guest having to remember to extend it via the thumb turn.

Handle options

To truly match the style requirements at your property, we also offer a wide range of handle options.

VingCard Standard Handles			
			
Ship Handle	US Ship Handle* ¹	Standard Handle	Functional ANSI Handle
			
Wing Handle	Straight Handle	Gothic Handle	Special Handle (45 slant)**

*¹ - Available only for Classic Lock.
 **² - To be installed on the inside of door, regular handle is needed on the outside.

Finishes

Offering one of the industry's widest choices of finishes, VingCard electronic locks can be configured to truly match the design of any property. *



* Pictures of finishes might differ from reality.



Designers' Handle Collection

Because your hotel requires the most exclusive and luxury touch, and you want to offer a personal and unique experience to your guests, ASSA ABLOY Global Solutions has created an optional Designers' Collection in order to offer you the most extensive and exclusive designer handles for electronic locks today.

VingCard has partnered with the following renowned designers through the famous Italian handle crafter Valli&Valli: Norman Foster and Partners, Gustav Peichl, Antonio Citterio, Gregotti Associati, Sottsass Associati and Taller Design Ricardo Bofill. Our designer handles are compatible with Signature, Essence and Allure.

Valli & Valli Designer Handles



Fusital H334



Fusital H317



Fusital H338



Fusital H329



Fusital H343



Fusital H359



Fusital Inox H5008



Fusital Inox H5015



Valli & Valli H123



Valli & Valli H120

Valli & Valli Designer Handles



Valli & Valli K1160



Valli & Valli H1026



Valli & Valli H1037



Valli & Valli H1039



Valli & Valli H1040



Valli & Valli H1049



Valli & Valli H1050



Valli & Valli H1051



Valli & Valli H1054



Valli & Valli H10554

Valli & Valli handles are available 10 different finishes:
Polished Chrome, Satin Chrome, Polished Brass, Satin Brass, Titanium, Matt Bronze, Brownish, Matt Black, Polished Stainless Steel, Satin Stainless Steel.

Electronic Locks

Comparison Table

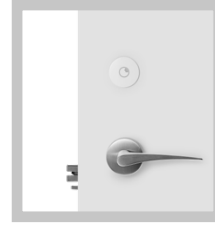

Features

ALLURE

ESSENCE

E100

Features	ALLURE	ESSENCE	E100
Lockcase	ANSI, EURO, JPN and AUS	ANSI, EURO, JPN and AUS	DIN and SIS, minimum backset 40mm
Panic release	Yes	Yes	Depending on lock case
Auto deadbolt	Optional	Optional	Depending on lock case
Mechanical override	Optional	Optional	Optional
Cylinder events in audit trail	Yes	Yes	No
Reader technology	RFID only or RFID + BLE	RFID only or RFID + BLE	RFID
RF-online upgradeable	Yes	Yes	No
Anti-Cloning technology - RFID cards	Yes	Yes	Yes
System software compatibility	Visionline & Vostio	Visionline & Vostio	Visionline
Online compatibility	Visionline Wireless (ZigBee) or Visionline Wired (PoE)	Wireless (based on ZigBee protocol) in Visionline	No
Power supply	3 AA batt + 12-24V ext	3 AA batteries	1 x Lithium CR123
Automatic unlock/lock	Yes	Yes	Yes
Passage mode	Yes	Yes	Yes, with stand open card
Audit trail	Offline: 3000 Online: Unlimited (local server)	Offline: 3000 Online: Unlimited (local server)	Offline: 14000
Guest privacy function	Yes	Yes	No
Finishes	7	7	1
Reader/Panel colors	Black, white or custom	Black or white	Black
Handles	Standard + Designer	Standard + Designer	L-shape & U-Shape
UL fire listed	Yes	Yes	No
Mobile Access compatible	Yes	Yes	No



Features

SIGNATURE RFID

CLASSIC RFID

FLEX

Lockcase	ANSI, EURO, US ANSI, JPN & AUS	ANSI, EURO, US ANSI, JPN & AUS	TLX 9025/9050/DIN, ASSA524 Tubular latches: Lockwood 530, Yale 280
Panic release	Yes	Yes	Yes
Auto deadbolt	Optional	Optional	No
Mechanical override	Optional	Optional	Optional
Cylinder events in audit trail	Yes	Yes	Yes
Reader technology	RFID only or RFID + BLE	RFID only or RFID + BLE	RFID only or RFID + BLE
RF-online upgradeable	Yes	Yes	Yes
Anti-Cloning technology - RFID cards	Yes	Yes	Yes
System software compatibility	Visionline & Vostio	Visionline & Vostio	Visionline & Vostio
Online compatibility	Wireless (ZigBee) in Visionline. Wired (PoE/Ethernet) in Visionline	Wireless (ZigBee) in Visionline.	Wireless (ZigBee) in Visionline
Power supply	3 AA batteries ⁽¹⁾	3 AA batteries ⁽¹⁾	3 AA batteries ⁽¹⁾
Automatic unlock/lock	Yes	Yes	Yes
Passage mode	Yes	Yes	Yes
Audit trail	Offline: 3000 Online: Unlimited (local server)	Offline: 3000 Online: Unlimited (local server)	Offline: 3000 Online: Unlimited (local server)
Guest privacy function	Yes	Yes	Yes
Finishes	7	7	2
Reader/Panel colors	Black or white	Black or white	Black
Handles	Standard + Designer	Standard	Straight & Return ⁽²⁾
UL fire listed	Yes	Yes	Yes
Mobile Access compatible	Yes	Yes	Yes

1) Up to 2 years normal lifetime.

2) Special handle for the State of California





4. Elsafe Electronic Safes

Electronic in-room safes contribute to raising the security level in your hotel, increasing your guests' peace of mind.

Our in-room safes are tested by the world's most recognized and respected product testing organization Underwriters Laboratories. Elsafe Infinity is the first UL-listed in-room safe in the 1037 category for anti-theft devices. This prestigious UL listing is now awarded to both the Infinity and Sentinel models, including physical break-in tests, endurance tests and jarring tests.

The exclusive UL-1037 listing achieved by Elsafe's in-room safes gives you added assurance that your guests' valuables are receiving the maximum level of protection possible. Not only does this protect your guests' property, it also protects your property's valuable reputation. With Elsafe, your guests can rest easy and so can you.

Electronic Safes

Elsafe Infinity II

Elsafe's Infinity II series introduces, a new era in hotel in-room safes. Infinity II is ideal for the most demanding hotels, lifestyle brands and boutique properties that strive to be different. By combining sophisticated technology and fashionable design, Infinity II is the ultimate safe for the design-conscious hotelier.

Standard features:

- UL-1037 certified for physical security.
- Industry-leading audit trail.
- Confirmation buzzer.
- Convenient inside light.
- Anti-tamper switch.
- Easy outside battery change.
- Unique modular construction for easy upgradeability.
- Spring-loaded door.
- Backlit keypad.



Security - UL Listed

This prestigious UL listing is now awarded to both the Infinity and Sentinel models, including physical break-in tests, endurance tests and jarring tests.



Electronic Safes

Elsafe Sentinel II

Elsafe goes beyond the ordinary with its new Sentinel II hotel in-room safe series. We have taken in-room security to a new level and combined it with a functional and trendy design. Sentinel II electronic in-room safe is more than just an in-room safe. It has become an important style element that blends into any environment! This new safe series operates with digital keypad.

Elsafe Sentinel II Digital in-room safe gives you the highest standard in hotel in-room security with the UL-1037 certification. Our hotel safes set the pace with the most unique features offered in electronic safes for hotels.

Standard features:

- UL-1037 Certified for physical security.
- Industry-leading audit trail.
- Easy outside battery change.
- Spring-loaded door.
- Unique modular construction for easy upgradeability.
- Backlit keypad.
- Convenient inside light.

How does UL-listing benefit you?

The exclusive UL-1037 listing achieved by Elsafe's in-room safes gives you added assurance that your guests' valuables are receiving the maximum level of protection possible. Not only does this protect your guests' property, it also protects your property's valuable reputation.



Electronic Safes

Elsafe Zenith

The choice of in-room electronic safes becomes easy when you can choose Elsafe Zenith to secure your guests' belongings. Zenith is advanced and economical security, with the industry's leading audit trail system that allows you to print out comprehensive reports on all safe activities.

- Industry-leading audit trail.
- Backlit keypad.
- Spring-loaded door.
- Anti-tamper labyrinth.
- Unique triangular locking bolt reinforcement.
- Easy outside battery change
- Convenient inside light.

Zenith safes options

Zenith is available in many sizes and models to complement your room regardless of style and need.

Zenith Drawer

Zenith Drawer is the ideal solution for hoteliers who want to maximize convenience for their guests and encourage use of the in-room safe. It provides superior design flexibility, allowing for placement inside drawers, cupboards...or anywhere in the room that it is most accessible and easy for guests to use.



Zenith Standard

The standard Zenith (ZD27/ZD43/ZDWI) can accommodate up to 17" laptop and meets any guestroom space limitation and location requirement.





Zenith In-Wall

Zenith In-Wall Safe is the ideal solution for hotels that need to maximize limited guestroom space. Zenith In-Wall Safe fits perfectly on any cupboard, armoire or closet wall as well as on the guestroom wall.



Zenith Floor and Drop

Zenith Floor and Drop is a large size safe mounted to the floor that provides ample storage space for exclusive suites and back offices.



Electronic Safes

Comparison Table

Features	Infinity II Series	Sentinel II Series	Zenith Series
UL-Listed	UL 1037	UL 1037	No
Audit log	Yes	Yes	Yes
Flash memory	Yes	Yes	Yes
Reprogrammable config.	Yes	Yes	Yes
ADA compliant keyboard	Yes	Yes	Yes
User operation	4 or 6 digit	4 digits	4 digits
LED display	Yes	Yes	Yes
Backlit keypad	Blue	Green	Green
Internal light	Yes	Yes	Yes
Power supply	5 AA batteries / 110 - 230VAC	5 AA batteries	5 AA batteries
Low battery warning	Yes	Yes	Yes
Easy external battery change	Yes	Yes	Yes
Spring-loaded door	Yes	Yes	Yes
Laptop compatible	Yes, up to 17" laptop Infinity 49	Yes, up to 17" laptop Sentinel 49	Yes, up to 17" laptop with Wide, in Wall and Floor
Service unit	SafeLink SW & PinKey	SafeLink SW & PinKey	SafeLink SW & PinKey
Anti-tamper labyrinth	Yes	Yes	Yes
Anti-tamper switch	Yes	Optional	Optional
Audio feedback	Yes	No	No
Internal carpet	Yes	Yes	Yes
Locking method	Shut & lock push button	Shut & lock push button	Lock push button
Locking mechanism	Interlocking deadbolt mechanism	Interlocking deadbolt mechanism	18 mm solid bolt
Door Construction	One piece cold pressed curved door	One piece cold pressed curved door	Flat steel door
Wireless RF online communication	Optional	Optional	Optional
Rental mode	Optional	Optional	Optional
Internal power outlet	Optional	Optional	Optional
RFID interface	Optional	Optional	No

Electronic Safes

Additional Information

Colors

	Infinity II Standard	Infinity II Option 1	Infinity II Option 2	Sentinel II	Zenith Drawer/Floor/In Wall	Zenith 27/43/Wide
Body color:	Black	White	Black	Black Gray	Black Gray/Ivory/ White	Black Gray/Ivory/White
Frame:	Glossy black	Glossy white	Gold	Gray	N/A	Black Gray/Ivory/White
Front:	Glossy black & polished chrome ellipse	Glossy white & polished chrome ellipse	Gold & polished chrome ellipse	Silver	Gray/Ivory/White	Black Gray/Ivory/White
Color preview:						

Dimensions

		Infinity II 25	Infinity II 41	Infinity II 49	Sentinel II 25	Sentinel II 41	Sentinel II 49
Outside H/W/D Incl. keyboard	mm	206/437/260	206/437/421	206/437/502	206/437/260	206/437/421	206/437/502
	inches	8 ¹ / ₈ /17 ³ / ₁₆ /10 ³ / ₁₆	8 ¹ / ₈ /17 ³ / ₁₆ /16 ⁵ / ₈	8 ¹ / ₈ /17 ³ / ₁₆ /19 ¹³ / ₁₆	8 ¹ / ₈ /17 ³ / ₁₆ /10 ³ / ₁₆	8 ¹ / ₈ /17 ³ / ₁₆ /16 ⁵ / ₈	8 ¹ / ₈ /17 ³ / ₁₆ /19 ¹³ / ₁₆
Inside H/W/D	mm	202/433/168	202/433/330	202/433/411	202/433/168	202/433/330	202/433/411
	inches	7 ¹⁵ / ₁₆ /17 ¹ / ₁₆ /6 ⁹ / ₁₆	7 ¹⁵ / ₁₆ /17 ¹ / ₁₆ /13	7 ¹⁵ / ₁₆ /17 ¹ / ₁₆ /16 ³ / ₁₆	7 ¹⁵ / ₁₆ /17 ¹ / ₁₆ /6 ⁹ / ₁₆	7 ¹⁵ / ₁₆ /17 ¹ / ₁₆ /13	7 ¹⁵ / ₁₆ /17 ¹ / ₁₆ /16 ³ / ₁₆
Door dimensions	mm	148/320	148/320	148/320	148/320	148/320	148/320
	inches	5 ¹³ / ₁₆ /12 ⁵ / ₈	5 ¹³ / ₁₆ /12 ⁵ / ₈	5 ¹³ / ₁₆ /12 ⁵ / ₈	5 ¹³ / ₁₆ /12 ⁵ / ₈	5 ¹³ / ₁₆ /12 ⁵ / ₈	5 ¹³ / ₁₆ /12 ⁵ / ₈
Internal volume	liters	14,1	27,7	34,5	14,1	27,7	34,5
	cu ft	0,50	0,98	1,22	0,50	0,98	1,22
Weight	kg	11,6	15,1	17,4	11,6	15,1	17,4
	lb	23,8	33,3	38,4	23,8	33,3	38,4

		Zenith Std. ZD 27	Zenith Std. ZD 43	Zenith Wide ZD WI	Zenith In-Wall ZD IW	Zenith Floor ZD FL	Zenith Drawer ZD 15	Zenith Drawer ZD 17
Outside H/W/D Incl. keyboard	mm	191/354/270	191/354/432	191/460/417	469/418/170	536/355/457	134/400 /350	134/460 /350
	inches	7 ³³ / ₆₄ /13 ¹⁵ / ₁₆ /10 ⁵ / ₈	7 ³³ / ₆₄ /13 ¹⁵ / ₁₆ /17	7 ³³ / ₆₄ /18 ¹ / ₈ /16 ²⁷ / ₆₄	18 ¹ / ₂ /16 ¹ / ₂ /6 ⁵ / ₈	21 ¹ / ₈ /14/18	5 ⁹ / ₃₂ /15 ³ / ₄ /13 ¹³ / ₁₆	5 ⁹ / ₃₂ /18 ¹ / ₈ /13 ¹³ / ₁₆
Inside H/W/D	mm	188/351/200	188/351/361	188/457/345	400 /350/95	500/349/371	62-124/ 397/347	62-124/ 457/347
	inches	7 ³ / ₈ /13 ¹³ / ₁₆ /7 ⁷ / ₈	7 ³ / ₈ /13 ¹³ / ₁₆ /14 ⁷ / ₃₂	7 ³ / ₈ /18/13 ¹⁹ / ₃₂	15 ³ / ₄ /13 ³ / ₄ /3 ³ / ₄	19 ¹¹ / ₁₆ /13 ³ / ₄ /14 ⁵ / ₈	2 ⁷ / ₁₆ - 4 ⁷ / ₈ /15 ⁵ / ₈ /13 ¹¹ / ₁₆	2 ⁷ / ₁₆ - 4 ⁷ / ₈ /18/ 13 ¹¹ / ₁₆
Door dimensions	mm	140/295	140/295	140/400	390/300	460/226	400 /350	460/350
	inches	5 ¹ / ₂ /11 ⁵ / ₈	5 ¹ / ₂ /11 ⁵ / ₈	5 ¹ / ₂ /15 ³ / ₄	15 ¹ / ₃ /11 ⁴ / ₅	18 ¹ / ₈ /8 ¹⁵ / ₁₆	15 ³ / ₄ /13 ¹³ / ₁₆	18 ¹ / ₈ / 13 ¹³ / ₁₆
Internal volume	liters	13	24	31,5	17,5	66	15	17
	cu ft	0,46	0,84	1,11	0,61	2,33	0,53	0,60
Weight	kg	7,8	10	12	20	36,2	8,27	9,4
	lb	16,8	21,6	26,5	44	79,8	18,23	20,72





6. System & Software

ASSA ABLOY Global Solutions serves as hospitality's leading provider of integrated software solutions that keep guests and staff members safe throughout every step of the hotel journey. Our cutting edge access management platforms provide hoteliers with the tools they need to always ensure a secure yet seamless hotel environment.

System & Software

Visionline

Visionline is built on the ZigBee Standard ISO 802.15.4 high-security open platform, the only wireless, highly-secured and open standards-based platform to address the unique needs of low-power monitoring and access-control network applications. Operating on a reliable and secure platform like ZigBee provides increased reliability and performance at an affordable cost. In addition, the wireless network enables smooth interface and integration opportunities for other online devices, including safes and minibars.

- : More Security and Control
- : More Services to your Guests
- : More Efficient and Cost Effective Operations
- : More Efficient Front Desk Operations
- : More Efficient Engineering and Maintenance

Visionline Options

Visionline is a highly flexible system that can consist of a combination of offline and online doors. Both wireless ZigBee and wired Ethernet can be used to create the most efficient system for your individual property needs. For Visionline wired online, PoE can be used as well.



Visionline Software Packages

Visionline is modular and consists of several different online modules that can be built as you prefer. These modules are Standard, Advanced, Communication, Safety, Online In-room Safe, Mobile Access and Loyalty program.

Standard Online Module

- : Central card cancellation
- : Remote audit trail
- : Low battery report
- : Extended stay
- : Room move
- : Auto check-out of guest card
- : Data Warehouse

Communication Module

- : SMS/E-mail alert
- : On screen alarm panels

Loyalty Program Module

- : Remote check-in/check-out
- : Bypassing reception queues
- : Using RFID loyalty guest card

Advanced Online Module

- : Door ajar alarm
- : Inside opening audit trail
- : Wandering intruder alert
- : Sequential intruder alert
- : Block cards per user group and section
- : Live tracking of cards
- : Insert maintenance report card
- : Online passage mode activation

Mobile Access Module

- : Manages ASSA ABLOY Mobile Access credentials

Online In-room Safe Module

- : Warning if safe is locked upon check-out
- : Low battery warning
- : Mechanically opened alert
- : Clear safe memory warning
- : Automatic synchronization of date/time
- : Remote audit trail
- : Remote service reports

Safety Module

- : Open doors from a central location¹
- : Close doors from a central location¹

1. Special conditions apply



System & Software

Visionline Features and Benefits

Visionline is available in both offline and online mode. In offline mode your property will benefit from a customized and flexible security solution without compromising security or convenience. The offline version allows you to upgrade at any time.

	Features	Benefits	Offline	Online
FRONTDESK OPERATIONS	Automatic access	Keycard automatically activated upon check-in.	✓	✓
	Room assignment	SMS/E-mail can be sent to guest in advance with room number.		✓
	Change room	Remotely re-assign a room to a guest,		✓
	Validation period	Keycards are automatically de-activated upon check-out.	✓	✓
	Extended stay	Guests may extend their stay remotely from the reception.		✓
	Card update station	In offline scenarios the guests can use the Automatic Card Update Station to update the card and get a room number.	✓	✓
GENERAL OPERATIONS	Various alarms	Reduce manual monitoring of the property.	✓	✓
	Online room management	Block users, cancel access, reassign rooms, etc.		✓
	System integration	Add on to the system to include other product solutions...	✓	✓
MANAGEMENT OPERATIONS	Customized reports	Define criteria to create in report.	✓	✓
	Automatic reports	Reports automatically sent by e-mail SMS to pre-defined users/groups.		✓
	Unlimited options	No limit in number of reports.	✓	✓
SECURITY OPERATIONS	Wandering intruder alerts	Automatically detect if someone is trying to use a card in multiple doors, this automatically cancels the keycard.		✓
	Sequential intruder alert	Automatically detect if there are at least 5 failed access attempts with the same card in the same door. E.g. if a guest is on the wrong floor, hotel can send someone to assist.		✓
	Automatic cancellation of keycards	By a press of a key the card will be cancelled in all online doors (both guest and master cards).		✓
	Block access to specific areas	Due to security issues, maintenance, etc.	✓ ¹	✓
	Track users	See the user's last registered location.		✓
	Door ajar alert	A message is sent to the server that a door is unclosed.		✓
MAINTENANCE OPERATIONS	Reporting cards	Use a customized card to report maintenance needed, e.g. "electrician needed".		✓
	Audit trail	Audit trails for the locks or safes can be downloaded from the Visionline server without going to the room.	✓ ²	✓
	Maintenance report	Automatically generate maintenance reports and perform preventative maintenance, e.g. low battery.		✓
	Maintenance counters	Automatically detect in which rooms or areas maintenance is needed.		✓
CASHLESS ENVIRONMENT	Payment card	Use same keycard as payment method in restaurants, shops, etc.	✓	✓
	Counter	Use counters to limit the number of times guests can access certain areas, e.g. 10 visits to the pool.	✓	✓

1. The operation have to be done by programming lock by lock manually.
2. Audit trails are available by performing a read-out directly from the lock itself



System & Software

Vostio Access Management

Vostio Access Management by ASSA ABLOY Global Solutions serves as a portfolio of cloud-based guest and staff access services for the hospitality industry. The first fully cloud-based platform of its kind, Vostio Access Management represents a revolutionary next step and offers a multitude of security and operational enhancing features that legacy access management systems are unable to offer:



connectivity

Secure access to all features & services from anywhere with online connectivity.



up-to-date

Instant & automatic software updates against newly identified threats.



GDPR ready

Total data confidentiality & transparency.



online servers

Eliminating the need for costly & bulky on-site servers.



off-site management

Complete off-site maintenance to preserve hotel labor resources.



future proof

Future proof & scalable to later add new functionalities.

Get Smart



Move to the cloud



System & Software

Vostio Benefits

Scalable. Secure. Simple. Intuitive. That's Vostio. Vostio provides guest access management flexibility and control for all types of establishments, whether a hostel, independent boutique brand or upmarket hotel chain.



Cloud-based



User-friendly



Secure

Chain/Ownership Group

- : Reporting and transparency
- : Global data protection compliance
- : Secure cloud storage and backups
- : No on-premises servers
- : Compliance assurance due to automated patch management
- : 24/7 availability, scalability and redundancy
- : Remote system control

Hotel Manager

- : Easy to install
- : Smooth operations
- : Cost efficient
- : Select the right functions
- : Remote monitoring
- : Scalable and flexible IT resources
- : Audit trails and traceability
- : Cloud security against data theft, leakage and deletion

Front Desk

- : Intuitive user interface
- : Efficient operations
- : PMS integrations
- : Space-saving keycard encoding

Technician

- : No local system maintenance
- : Asset management control
- : Easy troubleshooting and replacements
- : Notifications and alarms
- : Always secure and monitored

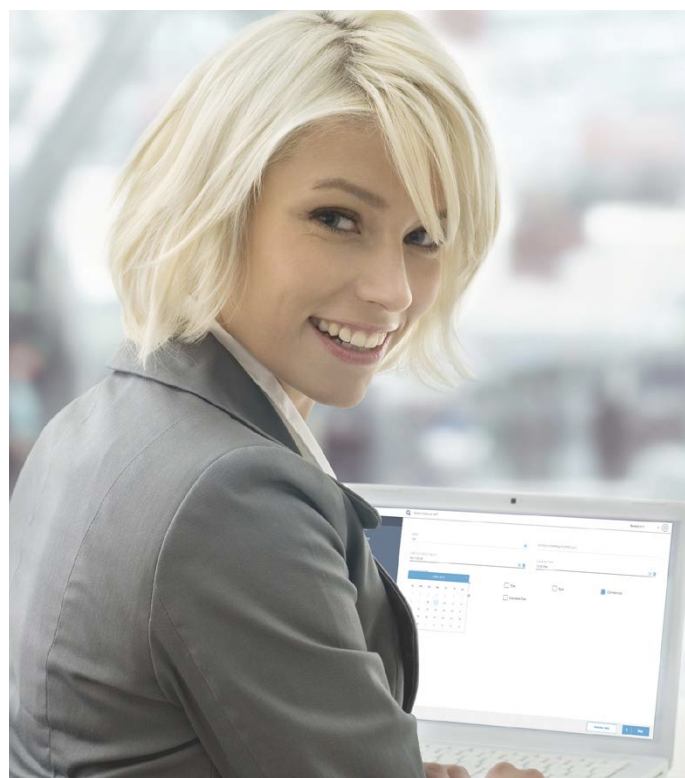

System & Software

IoT Location Solutions

Location Solutions let you embrace the importance of place as an integral part of your business strategy. It's where you tap into the mindset of your guests. Where you help safeguard employees. Where operations become far more efficient. And where you can create more value for your guests and for your business.

Location Solutions in brief

- WHO** Your guests, employees and partners
- WHAT** A wireless infrastructure using the Internet of Things (IoT) and Bluetooth Low Energy (BLE) technology to provide integrated real-time and proximity indoor location services
- WHY** Enhance guest experience, ensure employee safety, safeguard assets and streamline operations
- WHEN** As soon as possible to gain competitive advantage
- WHERE** Throughout your property
- HOW** Sensor beacons and gateways use BLE, a de facto standard, to connect guest and employee smartphones and share data on guest preferences and location with the cloud.

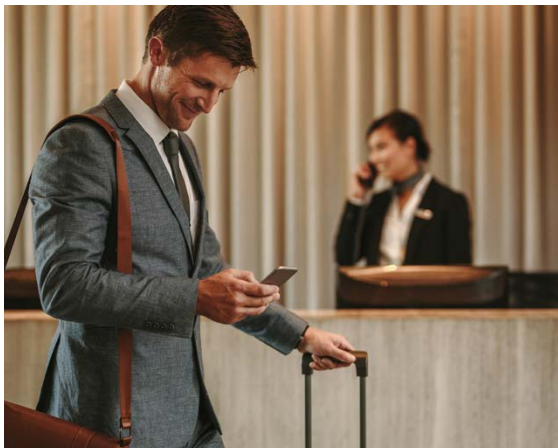

System & Software

Staff Safety

With Location Solutions- Staff Safety, hoteliers can finally provide their employees with the peace-of-mind and assurances of safety that they seek when at work. Staff Safety fully caters to the 5-Star promise by the American Hotel and Lodging Association (AHLA), a commitment by the industry's major hotel brands to provide staff with a seamless method of requesting help the moment they feel threatened.

Guaranteeing Staff Safety in Three Easy Steps

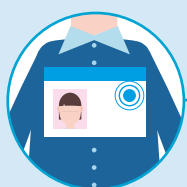

1. Click the button



2. Pinpoint Alarm Location



3. Send security

1. Threatened employee presses the distress button on alert device to activate an alert.
2. Device transmits distress signal to nearby BLE gateway. BLE gateway transmits signal via cloud to first responders and monitor portal.
3. First responders receive text message with location of employee.

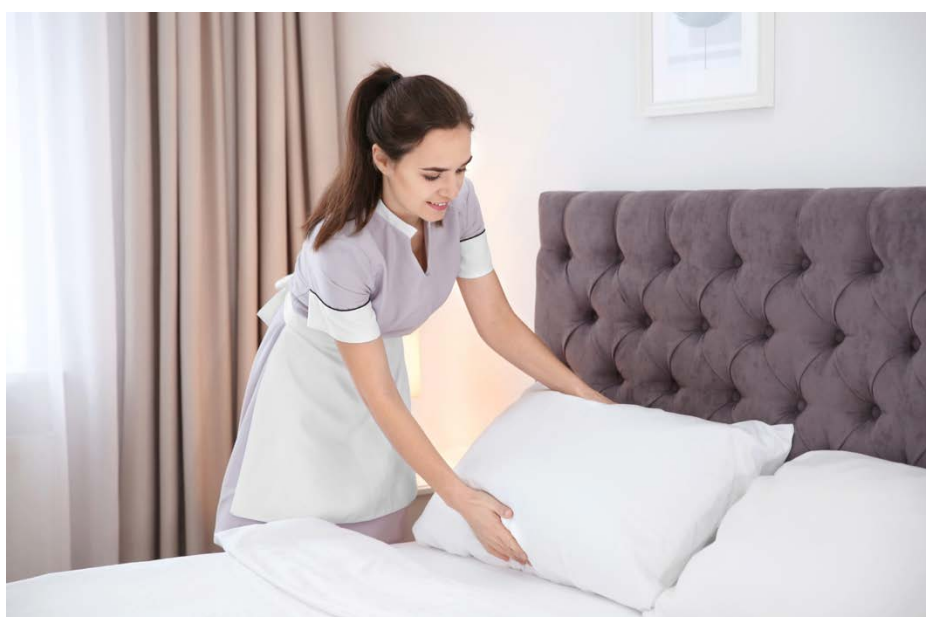





7. Accessories

ASSA ABLOY Global Solutions offers an extensive range of accessories and security hardware options to complement your hotel locking system and provide enhanced security.

These include such items as keycards and RFID carriers, as well as complementary hardware for cohesive guestroom design, such as bathroom locks, door retainers, door viewers. Back-of-house and facility access hardware, such as elevator controllers, exit devices and more are also included in our product range, and are designed to meet various standards. An overview of our comprehensive offerings is provided on the following pages.

Accessories

Radio Frequency Identification Technology

Radio Frequency Identification, contactless technology

VingCard RFID electronic locks share the same technology together with the RFID safes from Elsafe. Our RFID locks offer the latest Radio Frequency Identification (RFID) technology with the most flexible platform for future applications:

- 13,56MHz technology.
- Compatible with following standards:
 - : ISO 14.443 A (MIFARE)
 - : ISO 14.443 B
 - : ISO 15.693
- Compatible with NFC (Near Field Communication) and BLE (Bluetooth Low Energy) Technology. NFC and BLE technology enable contactless communication between our electronic locks and cell phones equipped with NFC and/or BLE.

Benefits with RFID technology:

- More Guest Satisfaction: Unmatched ease of use for guests of all ages. No need to insert the keycard.
- More Security: Anti-cloning technology for all guest and staff cards. Unlike magnetic strip whose keycards can be cloned, RFID technology allows powerful anti-cloning solution
- More Adaptability: RFID keycards and carriers adapt to any hotel style. You can choose from low cost guest cards, long lasting staff cards, wristbands and keyfobs to perfectly match different hotel types such as Business, Resort, Spa, All-inclusive payment).
- BLE Bluetooth Low Energy and NFC (Near Field Communication).
- More Information and Control: VingCard RFID electronic lock can write back information on staff RFID keycards for better information and management such as staff card audit trail, low battery status, cylinder tamper alarm.
- More Integration: You can integrate and interface VingCard RFID keycards with other applications at your hotel (loyalty programs, vendor payment, etc.)
- More Exclusivity: Provide a new experience for your customers and enhance the image of your hotel
- More Durability: VingCard RFID electronic lock components are sealed and provide better performance for outdoor use.
- More Selection: Provides access today to next generation technologies such as BLE Bluetooth Low Energy and NFC (Near Field Communication).
- More Standards: VingCard RFID electronic locks offer 4 technology standards in 1 electronic lock.

RFID Carriers

ASSA ABLOY Global Solutions offers a wide range of RFID carriers that are especially designed for different applications (for guests, staff or VIP guests) and give you the opportunity to enhance your guests' experience at your hotel.



Keycard

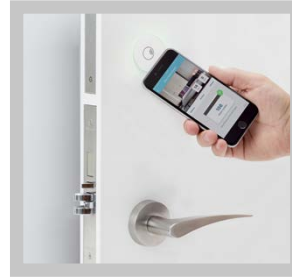

Smartphone



Wristband



Keyfob



Accessories

Wide Variety of Accessories

RFID Remote Controller

This independent unit provides access control to common doors, such as parking, health clubs, conference suites, staff entrances or guest night entrances. VingCard Remote Controllers are fully compatible with all of VingCard's card locking systems and Mobile Access compatible.



RFID Elevator Controller

VingCard's Elevator Controller is designed to be built into the elevator panel and operates offline. The security level of the hotel will increase, as only guests with a valid keycard will have access to the elevators/floors.

The Elevator Controller is compatible with all of VingCard's card locking systems and is Mobile Access compatible.



RFID Exit Device

Our Exit Device works with your VingCard electronic card locking system. This makes it possible to use encoded cards to control all guest and staff access to the building, while providing a panic exit device to satisfy all safety considerations for emergency exit. Opening the door from the inside is achieved by simply pushing the push bar.



Mechanical Locks

Bathroom Locks

VingCard's Bathroom Lock has an occupancy indicator and a thumb turn, making it easy to change the lock case handing from left to right. The Bathroom Lock is delivered in Satin Chrome, Satin Brass, Polished Chrome and Polished Brass.



Mechanical Locks for Back of House

The VingCard 1000-series cylinder locks are designed to complement VingCard's electronic locks, ensuring uniform appearance in guestrooms and corridors.

- Available in ANSI and EURO.
- Staff key will fit into cylinder keyways.
- UL-fire listed.
- Finish Materials: Satin Chrome, Satin Brass, Polished Chrome, Polished Brass.



Additional Items

Door Viewer

ASSA ABLOY Global Solutions high quality Door Viewer with glass lens has a super wide 200° all round clear angle of view. The to enhance your system is delivered in Satin Chrome or -Brass and Polished Chrome or -Brass.



Door Retainer

ASSA ABLOY Global Solutions Door Retainer prevents entry of intruders and increases the resident's safety. Is delivered in Satin Chrome or -Brass and Polished Chrome or -Brass.



Energy Control Unit

ASSA ABLOY Global Solutions offers a complete range of in-room Energy Control Units, the perfect combination for providing in-room comfort to your residents while, saving energy and money when they are away from their rooms.



Locker Lock

The RFID Locker Lock is a contactless operated lock the ideal for spa and wellness centers, ski resorts, golf clubs, sport and gym centers and is fully compatible with VingCard RFID locking system.



Polarbar Minibars

Polarbar offers a wide range of minibars. For more information about Polarbar, please visit: www.assaabloyglobalsolutions.com







8. Worldwide Service

Offering top-of-the-line customer service has always been a priority at ASSA ABLOY Global Solutions. No matter where you are in the world or which product you are using, we dedicate ourselves to providing the best support and guidance, whenever you need it.

ASSA ABLOY Global Solutions's extensive international network covers more than 166 countries giving us the ability to offer global sales and support for our customers. Our global network allows our valued customers to enjoy the benefits of worldwide resources, convenience of local service, and round-the-clock support 24 hours a day, 365 days a year *. Our technical support technicians are available worldwide to answer any questions or concerns you may have, giving you the support you want when you need it most.

ASSA ABLOY Global Solutions believes every customer is a customer for life, committing us to a partnership with all of our customers in the hospitality industry.

For more information on our Worldwide Service and local locations, visit our Service & Support page at: www.assaabloyglobalsolutions.com

* 24/7 support is subject to local service and maintenance contract terms. Please contact your local representative for local service hours.

The ASSA ABLOY Group is the global leader in access solutions. Every day we help people feel safe, secure and experience a more open world.

ASSA ABLOY
Global Solutions

ASSA ABLOY Global Solutions APAC
apac.globalsolutions@assaabloy.com
Phone: +852 23162200

ASSA ABLOY Global Solutions EMEA
emea.globalsolutions@assaabloy.com
Phone: +47 69 24 50 00

ASSA ABLOY Global Solutions North America
nam.globalsolutions@assaabloy.com
Phone: +1 972 907 2273

ASSA ABLOY Global Solutions Latin America
lac.globalsolutions@assaabloy.com
Phone: +52 55 36 40 12 00